



AMP | Timer Connector System

TE Internal #: 963245-1

Automotive Seals & Cavity Plugs, Single Wire Seal (SWS), Cavity Diameter .283 in [7.2 mm], Silicone, Poor, 50, Timer Connector System

[View on TE.com >](#)

Connectors > Automotive Connectors > Seals & Cavity Plugs



Connector Seal Type: **Single Wire Seal (SWS)**

Cavity Diameter: **7.2 mm [ .283 in ]**

Accepts Cable Insulation Diameter Range: **3.7 mm [ .146 in ]**

Seal Material: **Silicone**

Resistance to Hydrocarbons: **Poor**

**Features**

**Product Type Features**

Connector Seal Type	Single Wire Seal (SWS)
---------------------	------------------------

**Body Features**

Seal Material	Silicone
Primary Product Color	Yellow

**Dimensions**

Cavity Diameter	7.2 mm[.283 in]
Accepts Cable Insulation Diameter Range	3.7 mm[.146 in]

**Usage Conditions**

Operating Temperature (Max)	65 °C, 70 °C, 75 °C, 80 °C, 85 °C, 90 °C, 100 °C, 105 °C, 110 °C, 120 °C, 125 °C, 130 °C [149 °F][158 °F][167 °F][176 °F][185 °F][194 °F][212 °F][221 °F][230 °F][248 °F][257 °F][266 °F]
Operating Temperature Range	-40 – 130 °C[-40 – 266 °F]

**Industry Standards**



UL Flammability Rating	None
------------------------	------

### Other

Resistance to Hydrocarbons	Poor
----------------------------	------

Shore A Hardness	50
------------------	----

Contains Lubricant	Yes
--------------------	-----

## Product Compliance

[For compliance documentation, visit the product page on TE.com>](#)

EU RoHS Directive 2011/65/EU	Compliant
------------------------------	-----------

EU ELV Directive 2000/53/EC	Compliant
-----------------------------	-----------

China RoHS 2 Directive MIIT Order No 32, 2016	No Restricted Materials Above Threshold
-----------------------------------------------	-----------------------------------------

EU REACH Regulation (EC) No. 1907/2006	Current ECHA Candidate List: JUNE 2022 (224) Candidate List Declared Against: JUNE 2022 (224) Does not contain REACH SVHC
----------------------------------------	---------------------------------------------------------------------------------------------------------------------------------

Halogen Content	Low Halogen - Br, Cl, F, I < 900 ppm per homogenous material. Also BFR/CFR/PVC Free
-----------------	-------------------------------------------------------------------------------------

Solder Process Capability	Not applicable for solder process capability
---------------------------	----------------------------------------------

#### Product Compliance Disclaimer

This information is provided based on reasonable inquiry of our suppliers and represents our current actual knowledge based on the information they provided. This information is subject to change. The part numbers that TE has identified as EU RoHS compliant have a maximum concentration of 0.1% by weight in homogenous materials for lead, hexavalent chromium, mercury, PBB, PBDE, DBP, BBP, DEHP, DIBP, and 0.01% for cadmium, or qualify for an exemption to these limits as defined in the Annexes of Directive 2011/65/EU (RoHS2). Finished electrical and electronic equipment products will be CE marked as required by Directive 2011/65/EU. Components may not be CE marked. Additionally, the part numbers that TE has identified as EU ELV compliant have a maximum concentration of 0.1% by weight in homogenous materials for lead, hexavalent chromium, and mercury, and 0.01% for cadmium, or qualify for an exemption to these limits as defined in the Annexes of Directive 2000/53/EC (ELV). Regarding the REACH Regulation, the information TE provides on SVHC in articles for this part number is based on the latest European Chemicals Agency (ECHA) 'Guidance on requirements for substances in articles' posted at this URL: <https://echa.europa.eu/guidance-documents/guidance-on-reach>

## Compatible Parts

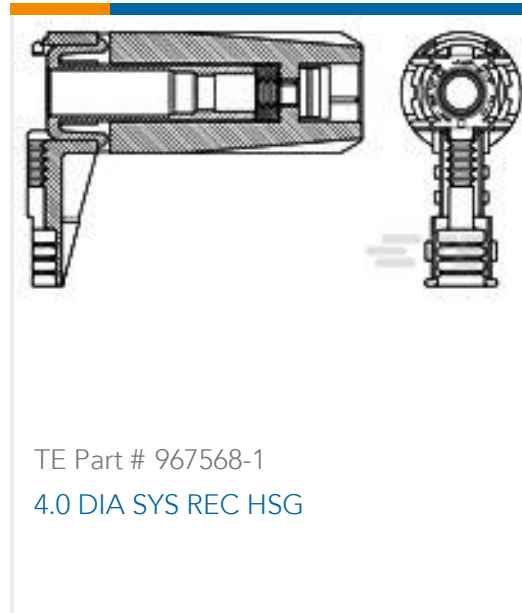
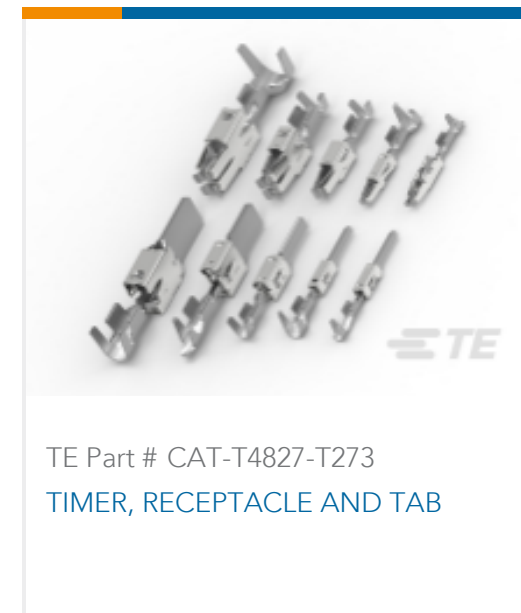
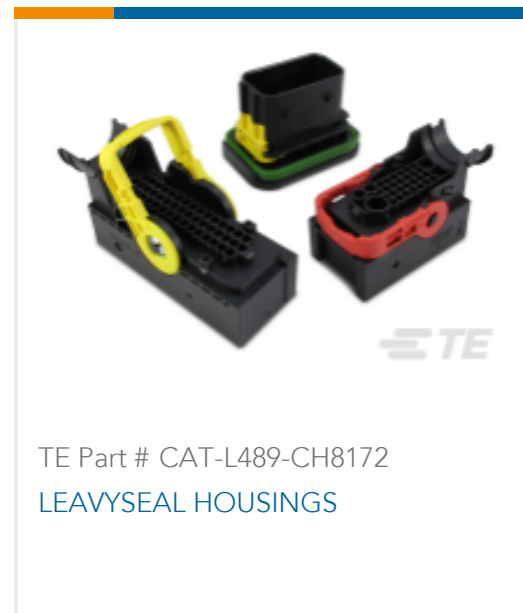

Also in the Series | **Timer Connector System**



Automotive Connector Caps &amp; Covers (11)

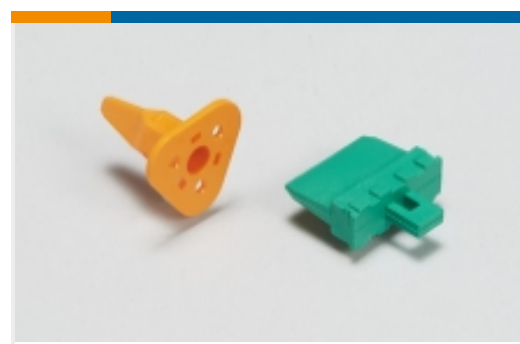

Automotive Connector Locks &amp; Position Assurance(16)



Automotive Housings(218)



Automotive Seals &amp; Cavity Plugs(31)



Automotive Terminals(130)

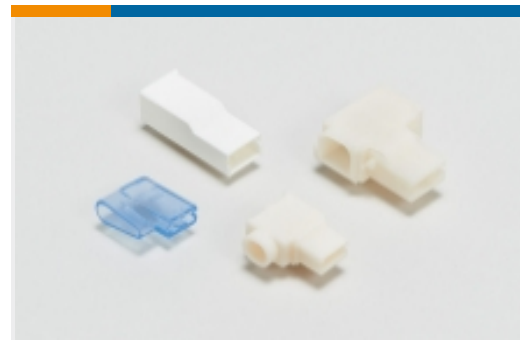

Crimp Terminal Housings(13)



Insertion &amp; Extraction Tools(20)

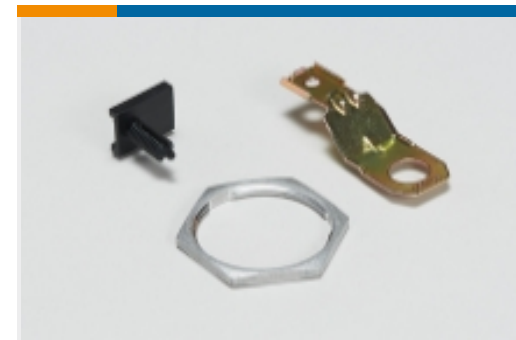

Other Automotive Connector Accessories(1)

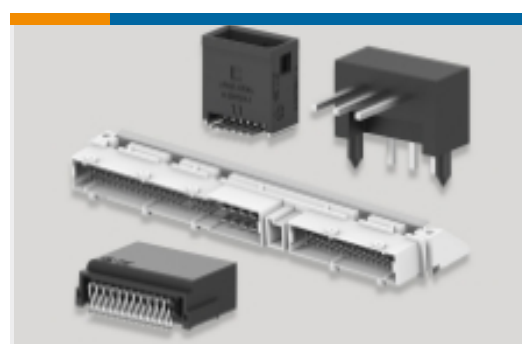

PCB Headers &amp; Receptacles(78)

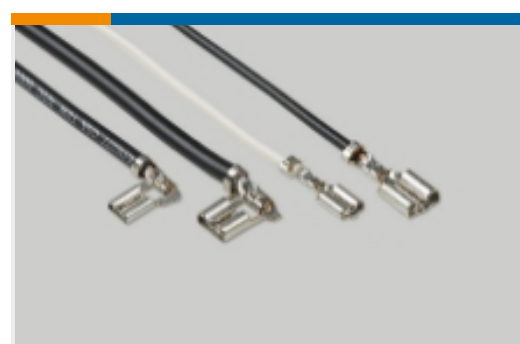

Quick Disconnects(4)

## Documents

### Product Drawings

#### INZELLEIT-DICHTUNG

English

### CAD Files

#### Customer View Model

[ENG\\_CVM\\_963245-1\\_C.3d\\_igs.zip](#)

English

#### Customer View Model

[ENG\\_CVM\\_963245-1\\_C.3d\\_stp.zip](#)

English

#### Customer View Model

[ENG\\_CVM\\_963245-1\\_C.2d\\_dxf.zip](#)

English

### 3D PDF

English

By downloading the CAD file I accept and agree to the [Terms and Conditions](#) of use.



**Product Specifications**

**Application Specification**

English

**Application Specification**

English

---

**Instruction Sheets**

**Instruction Sheet (non U.S.)**

French

**Instruction Sheet (non U.S.)**

French